

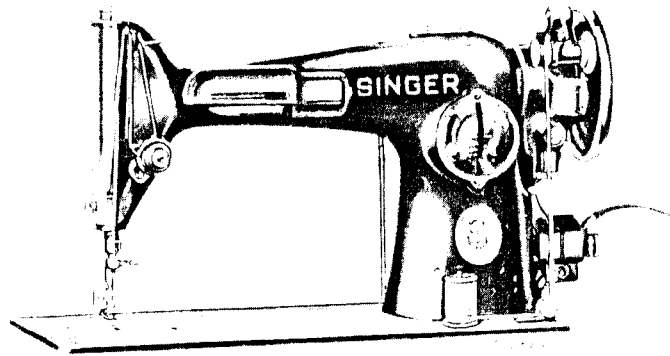
SINGER

1200-1

INDEX

	Page
Accessories.....	23
Attachment Set.....	23
Bias Gauge.....	24
Bobbin Winder.....	24
Braider.....	25
Border (Bow).....	25
Darning Foot.....	25
Edge Stitcher.....	25
Electrical Trimmings (For Table No. 100027).....	23
Electrical Trimmings (For Table No. 100053).....	23
Embroidery Attachment (For One Thread).....	25
Embroidery Attachment (For Two Threads).....	26
Feed Cover Plate.....	27
Feller (Foot).....	27
Hemmer (Foot).....	27
Hemstitcher.....	27
Knee Lifter.....	28
Machine Cover.....	28
Machine No. 1200-1.....	5
Needle Threader (Universal).....	29
Numerical List of Parts.....	33
Obsolete Parts.....	30
P.H. Motors.....	14
P.H. Motor Parts.....	14
Presser Feet.....	29
Quilter.....	30
Singerlight No. 193930.....	18
Singerlight Lamp.....	19
Treadle Controllers (Moulded).....	20
Tubular Trimming Attachment.....	30
Under Braider.....	30

LIST OF PARTS COMPLETE
FOR



MACHINE No. 1200-1

FOR DRESSMAKERS' AND HOME INDUSTRIAL
USE. ADJUSTABLE REVERSE FEED. P. H. MOTOR
AND SINGERLIGHT. KNEE LIFTER.

No.	Plate	Name
*22801	-----	Arm.....
22802	-----	" 22801 with 443C, 15404, 32503, 45207, 45208 and two each 448C and 15405.....
Note: Due to the accuracy required for Gear alignment, Arm cannot be supplied sepa- rately and can only be sent out as a unit Arm and Bed assembled.		
4389	22501	Arm Dowel Pin.....
125331	22501	" Oil Pad (felt) for oiling Arm Shaft (horizontal) Back Bear- ing.....
125333	22501	Arm Oil Pad Spring.....
125334ZB	22501	" " " Cap.....
138E	22501	" Screw.....
45299	22509	" Shaft (horizontal).....
45346	22559	" " " Bevel Gear (right hand spiral) with two 1259C.....
1259C	22501	Arm Shaft (horizontal) Bevel Gear Set Screw.....

No.	Plate	Name
51280ZB	22514	Clamp Stop Motion Clamp Screw....
246ZA	22508	" " " " Stop Screw
125359	22514	" " " " Washer....
45294	22514	" " " " Flanged Bushing.
45295	-----	" " " " "
45294 with 51280ZB.....		
51320C	22501	Clamp Stop Motion Flanged Bushing Set Screw.....
45336	-----	Clamp Stop Motion complete, Nos. 246ZA, 45295, 51320C and 125359.
22804	-----	Face Plate.....
22805	22551	" " 22804 with 45214.....
50996ZP	22501	" " Screw.....
45214	22501	" " Thread Guard with 125373.....
125373	22501	Face Plate Thread Guard RivetPer 100
50984ZB	22501	Face Plate Thumb Screw.....
45215	22509	Feed Bar.....
315C	22501	" " Screw Center.....
*15445	-----	" " " " 315C with 1519J.....
1519J	22501	Feed Bar Screw Center Nut.....
45322	22510	" Cam and Feed Lifting Eccen- tric (counterbalanced) with 1289C.....
1289C	22501	Feed Cam and Feed Lifting Eccen- tric Position Screw.....
45217	22510	Feed Connecting Rod with 125044 and two 896E.....
896E	22501	Feed Connecting Rod Cap Screw....
375C	22501	" " " " Hinge Screw....
1515J	-----	" " " " " Nut
125044	22501	" " " " Oil Pad (felt)
45214	22513	" " " " 12 teeth (14 teeth to the inch) for 125319.....
209E	22517	Feed Dog Screw.....
45220	22503	" " Throw-out Lever with 181B
50991B	22505	" " " " Hinge Screw
181B	22505	" " " " Roller and Stud.....
51294J	22511	Feed Dog Throw-out Lever Thumb Screw.....
45221	22508	Feed Dog Throw-out Lever Thumb Screw Retaining Ring.....
45222	22510	Feed Parked Connection with 173J..
45221	-----	" " " " 45222 with 125335.....
173J	22501	Feed Parked Connection Adjusting Screw.....

No.	Plate	Name
45273	22507	Rotating Hook complete, Nos. 45272 and 45278.....
45274	-----	Rotating Hook and Bobbin Case complete, Nos. 45273 and 45276...
32522	22507	Rotating Hook Bobbin.....
*45275	-----	" " " Case.....
45276	22507	Rotating Hook Bobbin Case complete Nos. 1172F, 1173E, 45275, 45277, 45280 and 51302E.....
45277	22508	Rotating Hook Bobbin Case Finger..
51302E	22508	" " " " " Screw
45292	22507	" " " " Position Plate.....
45241	-----	Rotating Hook Bobbin Case Position Plate 45292 with 45293 and two 239E.....
45293	22508	Rotating Hook Bobbin Case Position Plate Loop Guard.....
239E	22508	Rotating Hook Bobbin Case Position Plate Loop Guard Screw.....
207J	22553	Rotating Hook Bobbin Case Position Plate Screw.....
45278	22507	Rotating Hook Bobbin Case Retaining Ring.....
45279	22508	Rotating Hook Bobbin Case Retaining Ring Spring.....
707E	22508	Rotating Hook Bobbin Case Retaining Ring Spring Screw.....
1172F	22508	Rotating Hook Bobbin Case Tension Regulating Screw.....
45280	22508	Rotating Hook Bobbin Case Tension Spring.....
1173E	22508	Rotating Hook Bobbin Case Tension Spring Screw.....
45242	22509	Rotating Hook Driving Shaft.....
45853	22559	" " " " Revel Gear (back) left hand spiral, with two 1259C.....
45244	22510	Rotating Hook Driving Shaft Bevel Gear (back) Cover complete, Nos. 45286 and 45287.....
*45286	-----	Rotating Hook Driving Shaft Bevel Gear (back) Cover Body.....
*45287	-----	Rotating Hook Driving Shaft Bevel Gear (back) Cover Body End Cap
203E	22508	Rotating Hook Driving Shaft Bevel Gear (back) Cover Screw.....
1259C	22501	Rotating Hook Driving Shaft Bevel Gear (back) Set Screw.....

No.	Plate	Name
45852	22559	Rotating Hook Driving Shaft Bevel Gear (front) right hand spiral, with two 1259C.....
45246	22510	Rotating Hook Driving Shaft Bevel Gear (front) Cover.....
207F	22553	Rotating Hook Driving Shaft Bevel Gear (front) Cover Screw.....
1259C	22501	Rotating Hook Driving Shaft Bevel Gear (front) Set Screw.....
45247	22504	Rotating Hook Driving Shaft Bushing (back).....
448C	22501	Rotating Hook Driving Shaft Bushing (back) Set Screw.....
45248	22504	Rotating Hook Driving Shaft Bushing (front).....
448C	22501	Rotating Hook Driving Shaft Bushing (front) Set Screw.....
60851	22508	Rotating Hook Driving Shaft Collar with 5015C.....
50150C	22508	Rotating Hook Driving Shaft Collar Set Screw.....
45281	22507	Rotating Hook Needle Guard.....
51306E	22508	" " " " Screw.....
45282	22508	" " Position Pin.....
50483F	22508	" " Screw.....
45249	22504	" " Shaft with 45281....
45349	22559	" " " Bevel Gear left hand spiral, with two 1259C.....
45251	22510	Rotating Hook Shaft Bevel Gear Cover.....
207E	22553	Rotating Hook Shaft Bevel Gear Cover Screw.....
1259C	22508	Rotating Hook Shaft Bevel Gear Set Screw.....
45252	22504	Rotating Hook Shaft Flanged Bushing.....
448C	22508	Rotating Hook Shaft Flanged Bushing Set Screw.....
45253	-----	Rotating Hook Slide.....
45335	22551	" " " Spring.....
51282ZJ	22508	" " " " Screw..
45254	22551	Rotating Hook Slide complete, Nos. 45253, 45335 and two 51282ZJ...
45345	22553	Slack Thread Regulator and Tension Thread Guide.....
2252B	22508	Slack Thread Regulator and Tension Thread Guide Screw.....
45306	22551	Stitch Indicator Plate.....
3352B	22508	" " " " Screw.....

No.	Plate	Name
45307	-----	Stitch Regulating Plate.....
45308	22552	" " " 45307 with 45289.....
45309	-----	Stitch Regulating Plate 45308 with 45306, 45310 and 51312ZB.....
51312ZB	22552	Stitch Regulating Thumb Screw....
*45289	-----	" " " " Bushing
125400	22552	" " " " Fric- tion Washer.....
45310	22552	Stitch Regulating Thumb Screw Washer (fibre).....
2102	22512	Tension Disc.....
45337	22512	" Index Flange.....
45340	22512	" " Stop Washer...
45338	22512	" Indicator.....
51670ZB	22512	" Regulating Thumb Nut with 45339.....
45339	22512	Tension Regulating Thumb Nut En- gaging Pin.....
32573	22514	Tension Releasing Lever.....
97E	22512	" " " Hinge Screw
12329	22512	" " " Spring....
45341	22512	" " Pin.....
125314	22512	" Spring.....
140121ZB	22512	" Stud.....
45344	-----	" " 140121ZB with 51670ZB
447C	22512	" " Set Screw.....
45342	-----	Tension (graduated) complete, Nos. 45337, 45338, 45340, 45341, 45343, 45344, 66774, 125314 and two 2102.....
26075ZB	22512	Thread Cutter and Holder.....
8422ZB	22512	" Guard (head of arm).....
32578	22514	" Take-up Crank.....
1036C	22512	" " " Set Screw....
45261	22511	" " Lever.....
45262	-----	Thread Take-up Lever complete, Nos. 45261, 45264 and 45265.....
45263	-----	Thread Take-up Lever 45262 with 45233 and 66593.....
45264	22512	Thread Take-up Lever Hinge Stud...
45265	22511	" " " Link.....
66593	22511	" " " " Hinge Stud
447C	22512	" " " " " " "
		Set Screw.....
66774	22512	Thread Take-up Spring.....
45343	22514	" " " Thread Guard
125319ZB	22513	Throat Plate for 45219.....
691ZA	22513	" " Screw.....

No.	Plate	Name
*15404	-----	Trade Mark.....
15405	-----	" " Rivet.....
24079	22557	Drip Pan with four 1 1/2 in. No. 14 wire nails.....

SINGER Needles should be used
in SINGER Machines.
These Needles and their Containers
are marked with the
Company's Trade Mark "SIMANCO.***" 1

Needles in Containers marked
"FOR SINGER MACHINES"
are NOT **SINGER** made needles. 2

P. H. MOTORS

CAT. NO.	AMP.	VOLTS	CYCLES	CURRENT
P.H.3	1.4	32	--	D.C.
P.H.5	1.1	50	25 to 75	A.C. and D.C.
P.H.6	0.6	95-100	"	"
P.H.7	0.6	100-110	"	"
P.H.9	0.5	115-125	"	"
P.H.9	0.4	150-165	"	"
P.H.10	0.3	200-220	"	"
P.H.11	0.3	210-230	"	"
P.H.12	0.3	230-250	"	"
P.H.15	0.5	130-145	"	"
P.H.87	0.7	100-110	80 to 100	"
P.H.90	0.4	200-220	"	"
P.H.92	0.3	230-250	"	"

P. H. MOTOR PARTS

No.	Plate	Name
193555	4960	Armature complete for P.H.3 Motor.
193556	-----	" " " P.H.5 Motor.
193557	-----	" " " P.H.6 Motor.
193557	-----	" " " P.H.7 Motor.
193553	-----	" " " P.H.8 Motor.
193559	-----	" " " P.H.9 Motor.
193560	-----	" " " P.H.10 Motor.
193561	-----	" " " P.H.11 Motor.
193561	-----	" " " P.H.12 Motor.
193563	-----	" " " P.H.15 Motor.
193563	-----	" " " P.H.87 Motor.
193564	-----	" " " P.H.90 Motor.
193560	-----	" " " P.H.92 Motor.
*193540	-----	Armature Core complete.....
*193528	-----	" Shaft.....
*193523	-----	" Bearing Sleeve (commutator end).....
447C	22512	Armature Shaft Bearing Sleeve (commutator end) Set Screw....
*193524	-----	Armature Shaft Bearing Sleeve (front end).....
506172B	22516	Armature Shaft Bearing Sleeve (front end) Cap Screw.....
447C	22512	Armature Shaft Bearing Sleeve (front end) Set Screw.....

No.	Plate	Name
193529	22515	Armature Shaft Pinion (spiral) with two 462C.....
462C	22516	Armature Shaft Pinion Set Screw....
193542	22516	" " Oil Sling.....
192457	22516	Brush (carbon) for 32 to 145 volts
193799	-----	" " " 150 to 250 volts
193543	22516	" Cap.....
192458	22516	" Spring.....
194113	22516	" Tube.....
193546	22516	" " Insulating Bushing.....
882E	22516	" " " " Set Screw.....
193536	4960	Commutator complete.....

The Part Numbers for the Field Coils (left and right) that are printed with an asterisk (*) will be furnished only when repairs to a motor are made at the factory.

No orders will be filled for left or right coils separately.

Agencies orders will only be filled with Field Coils complete comprising one left and one right coil.

*193566	-----	Field Coil (left) for 193565.....
*193567	-----	" " (right) for 193565.....
193565	-----	Field Coil complete, for P.H.3 Motor, Nos. 193566 and 193567....
*193569	-----	Field Coil (left) for 193568.....
*193570	-----	" " (right) for 193568.....
193568	-----	Field Coil complete, for P.H.5 Motor, Nos. 193569 and 193570....
*193572	-----	Field Coil (left) for 193571.....
*193573	-----	" " (right) for 193571.....
193571	-----	Field Coil complete, for P.H.6 Motor, Nos. 193572 and 193573....
*193575	-----	Field Coil (left) for 193574.....
*193576	-----	" " (right) for 193574.....
193574	22517	Field Coil complete, for P.H.7 Motor, Nos. 193575 and 193576....
*193578	-----	Field Coil (left) for 193577.....
*193579	-----	" " (right) for 193577.....
193577	-----	Field Coil complete, for P.H.8 Motor, Nos. 193578 and 193579....
*193581	-----	Field Coil (left) for 193580.....
*193582	-----	" " (right) for 193580.....
193580	-----	Field Coil complete, for P.H.9 Motor, Nos. 193581 and 193582....
*193584	-----	Field Coil (left) for 193583.....
*193585	-----	" " (right) for 193583.....
193583	-----	Field Coil complete, for P.H.10 and P.H.11 Motors, Nos. 193584 and 193585.....

No.	Plate	Name
*193587	-----	Field Coil (left) for 193586.....
*193588	-----	" " (right) for 193586.....
193586	-----	Field Coil complete, for P.H. 12 Motor, Nos. 193587 and 193588.
*193590	-----	Field Coil (left) for 193589.....
*193591	-----	" " (right) for 193589.....
193588	-----	Field Coil complete, for P.H. 15 Motor, Nos. 193590 and 193591.
*193593	-----	Field Coil (left) for 193592.....
*193594	-----	" " (right) for 193592.....
193592	-----	Field Coil complete, for P.H. 17 Motor, Nos. 193593 and 193594.
*193596	-----	Field Coil (left) for 193595.....
*193597	-----	" " (right) for 193595.....
193595	-----	Field Coil complete, for P.H. 90 Motor, Nos. 193596 and 193597.
*193599	-----	Field Coil (left) for 193598.....
*193600	-----	" " (right) for 193598.....
193598	-----	Field Coil complete, for P.H. 92 Motor, Nos. 193599 and 193600.
727511	22516	Field Coil Lead Bushing (rubber)..
*192954	-----	" " " Terminal Clip Body
*192955	-----	" " " " " "
		Cap.....
192424	22515	Field Coil Retainer.....
193541	4960	Field Core complete.....
51286R	22516	" " Screw.....
193526	22516	Grease Wick.....
193525	-----	" " 193526 with 193527....
193527	22516	" " Spring.....
51284R	22516	" " " Cap Screw.....
193640	22516	" " " Retainer.....
*194532	22558	Lead Cord.....
192851	22558	Lead Cord complete, from lamp socket to three-pin terminal, for Knee Control, Nos. 194518, 194532 and 194533.....
194518	22558	Lead Cord Plug (rubber).....
193544	4960	Motor Cover.....
224ZB	22516	" " Screw.....
193522	-----	" Frame.....
193545	4960	" " 193522 with 193523, 193524 and two each 447C and 882E.....
*193732	-----	Motor Frame 193545 with 1907B, 4526B, 45297, 51303ZB, 51319ZB, 66775, 125326ZB and 125365.....
51285E	22516	Motor Frame Screw.....
899454	-----	Name Plate, for P.H. 7 Motor.....
899453	22515	" " " all P.H. Motors ex- cept P.H. 7 Motor.....

No.	Plate	Name
*194519	-----	Three-Pin Terminal (female half) Housing (upper).....
*192844	-----	Three-Pin Terminal (female half) Housing (lower).....
51093R	22516	Three-Pin Terminal (female half) Housing Screw.....
1768R	22516	Three-Pin Terminal (female half) Housing Screw Nut.....
192692	22516	Three-Pin Terminal (female half) Insert Clamp.....
192691	22516	Three-Pin Terminal (female half) Insert Sleeve.....
*194533	22558	Three-Pin Terminal (female half) complete, Nos. 192844, 194519, two each 1768R, 51093R and three each 192691 and 192692.
*193933	-----	Three-Pin Terminal (male half) and Singerlight Switch Compartment
*193934	-----	Three-Pin Terminal (male half) and Singerlight Switch Compartment 193933 with three 192793....
192793	22516	Three-Pin Terminal (male half) Post.....
51582	22516	Three-Pin Terminal (male half) Post Thumb Nut.....
701719	22516	Three-Pin Terminal (male half) Post Washer.....
*193935	-----	Three-Pin Terminal (male half) and Singerlight Switch Compartment complete, Nos. 193934 and three each 51582 and 701719.....
194093	22519	Three-Pin Terminal (male half) Bracket.....
51293E	22516	Three-Pin Terminal (male half) Bracket Screw.....
50657R	22516	Three-Pin Terminal (male half) Screw.....

Form Released Under E.O. 14176

SINGERLIGHT No. 193930

No.	Plate	Name
193911	22558	Singerlight Lamp Socket.....
194050	22558	" " " 193911 with 193912, 194083 and two each 51399E and 193915.....
193912	22558	Singerlight Lamp Socket Cap with 193913.....
*193913	-----	Singerlight Lamp Socket Cap Insert
51399E	22553	" " " " Screw.
51367ZB	22553	" " " " Screw.....
701994	22553	" " " " Insu- lating Washer (felt).....
*193914	-----	Singerlight Lamp Socket Terminal Lug.....
191981	-----	Singerlight Lamp Socket Terminal Plunger.....
191980	-----	Singerlight Lamp Socket Terminal Plunger Housing.....
191982	-----	Singerlight Lamp Socket Terminal Plunger Spring.....
193915	-----	Singerlight Lamp Socket Terminal complete, Nos. 191980 to 191982 and 193914.....
*194074	-----	Singerlight Lead (yellow tracer thread) for 194073.....
*194084	-----	Singerlight Lead (white) for 194083.....
*192954	-----	Singerlight Lead Terminal Clip Body for 194073.....
*192955	-----	Singerlight Lead Terminal Clip Body Cap for 194073.....
194073	-----	Singerlight Lead (yellow tracer thread) complete for 194083, Nos. 192954, 192955 and 194074.
194083	-----	Singerlight Lead complete, Nos. 194073, 194075 and 194084.....
194075	22558	Singerlight Lead Tube, 10 7/8 in. long (wiremold).....
194082	22515	Singerlight Lead Tube Clamp.....
624C	22553	" " " " Set Screw
194085	-----	" " " " Clamping Plate (fibre).....
51401E	22553	Singerlight Lead Tube Clamping Screw.....

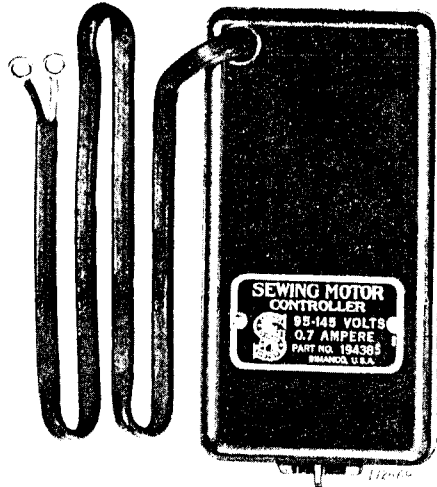
No.	Plate	Name
193931	22519	Singerlight Shade and Lamp Socket Housing with 51401E.....
*194273	-----	Singerlight Toggle Switch with 51484J, 51623 and 193919.....
*193893	-----	Singerlight Toggle Switch Lead....
*192954	-----	" " " " Ter- minal Clip Body.....
*192955	-----	Singerlight Toggle Switch Lead Terminal Clip Body Cap.....
51484J	22553	Singerlight Toggle Switch Lead Terminal Screw.....
193892	22515	Singerlight Toggle Switch Lead complete, Nos. 192954, 192955 and 193893.....
51623	22553	Singerlight Toggle Switch Lock Nut
193919	22553	" " " Thumb Nut (moulded).....
194274	22515	Singerlight Toggle Switch with Lead complete, Nos. 193892 and 194273.....
193930	-----	Singerlight (less lamp and switch) complete, Nos. 51367ZB, 193930, 194050, 194085 and 701994.....
641ZJ	22553	Singerlight Screw.....

SINGERLIGHT LAMP

No.	Plate	Name
194120	22519	Singerlight Lamp.....

Note: When ordering No. 194120, state volt-
age required.

TREADLE CONTROLLERS (Moulded)



No.	Plate	Name
194384	-----	Controller complete, for 32 to 55 volts, A.C. or D.C. Motor, Nos. 194426, 194455, 194491 and two 140102R.....
194385	-----	Controller complete, for 95 to 145 volts, A.C. or D.C. Motor, Nos. 194454, 194455, 194492 and two 140102R.....
194386	-----	Controller complete, for 150 to 250 volts, A.C. or D.C. Motor, Nos. 194426, 194455, 194493 and two 140102R.....
194322	22558	Controller Base with two 194419 and four 194400.....
194491	-----	Controller Base 194322 with 23258, 192211, 192985, 193908, 194422, 194479, two each 140100R, 140103R, 194421, 194514 and 931090.....
194492	-----	Controller Base 194322 with 23258, 192140, 192985, 193908, 194422, 194479, two each 140100R, 140103R, 194421, 194514 and 931090.....

No.	Plate	Name
194493	-----	Controller Base 194322 with 23258, 192141, 192985, 193908, 194422, 194479, two each 140100R, 140103R, 194421, 194514 and 931090.....
*194400	-----	Controller Base Insert (large hole)
*194419	-----	" " " (small hole)
194399	22558	" Bracket.....
194468	-----	" " 194399 with 126R and 1549R, for 194384 to 194386
126R	22554	Controller Bracket Screw.....
1549R	22554	" " " Nut.....
194323	-----	" Cover.....
194426	-----	" " 194323 with 899287 and two 964317.....
194454	22558	Controller Cover 194323 with 899287 and two 964317.....
140102R	22554	Controller Cover Screw.....
*194456	-----	" Lead.....
*194526	-----	" " Identification Tube (yellow).....
*194527	-----	Controller Lead Insulating Sleeve (3 1/16 in. long).....
*194528	-----	Controller Lead Insulating Sleeve (2 3/16 in. long).....
*191960	-----	Controller Lead Terminal Clip Body (controller end).....
*191961	-----	Controller Lead Terminal Clip Body Cap (controller end).....
*192954	-----	Controller Lead Terminal Clip Body (terminal end).....
*192955	-----	Controller Lead Terminal Clip Body Cap (terminal end).....
194455	22558	Controller Lead complete, from controller to three-pin terminal, Nos. 194456, 194526 to 194528 and two each 191960, 191961, 192954 and 192955.....
193908	22554	Controller Lead Clamp.....
194479	22554	" " " Insulation..
193828	22555	" Pitman Rod Connection..
192211	22519	" Resistance Unit, for 32 to 55 volts.....
192140	22519	Controller Resistance Unit, for 95 to 145 volts.....
192141	22519	Controller Resistance Unit, for 150 to 250 volts.....
192985	22555	Controller Resistance Unit Adjusting Nut (insulating) with 192303.....

ATTACHMENT SET

No.	Plate	Name
25537	22556	Screw Driver (machine).....
120378	22556	" " (shuttle tension)....
36583	4942	Tucker.....
121499	-----	Attachment Set Nos. 25527,25537, 35931,36583,50053B,120378, 120855,121464,two 8879,five 32522 and six needles.....
120598	4942	Ruffler, for one, six and twelve stitch ruffling.....
121500	-----	Attachment Set complete,Nos.120598 and 121499.....

BIAS GAUGE

No.	Plate	Name
25525	4958	Bias Gauge.....

BOBBIN WINDER

No.	Plate	Name
15072	21454	Bobbin Position Pin.....Per 100
66670	22524	Frame.....
45237	-----	" 66670 with 15288ZBand 66671ZE
51319ZB	21454	" Hinge Screw.....
125365	22553	" Spring.....
15287	22524	Friction Ring (rubber).....
15288ZB	22524	Pulley.....
66671ZB	22524	Spindle with 15072.....
2007ZB	22553	Spool Pin.....
8879	22501	" " Washer (cloth).....
4526B	22524	Stop Latch.....
51303ZB	21454	" " Hinge Screw.....
68775	21454	" " Spring.....
125395ZB	22524	Tension Bracket.....
45845	21454	" Disc.....
45847	21454	" " Spring.....
45846	21454	" " Disc.....
140138ZB	21454	" Screw.....
125396ZB	-----	Tension Bracket complete,Nos.45845 to 45847,125395 and 140138ZB..
193ZB	21454	Tension Bracket Screw.....
7071	21454	" " Washer.....
125328ZB	22524	Tripping Arm.....
190ZB	22553	" " Screw.....

BRAIDER

No.	Plate	Name
25510	4958	Braider.....
289B	4958	" Thumb Screw.....

CORDER (Bow)

FOR TOP CORDING

No.	Plate	Name
26398	1950	Corder Bow.....
4604	21454	" " Rivet.....Per 100
25789	1950	" " Tip.....
25794	1950	Presser Foot.....
26399	1950	Corder Bow complete,Nos.4604,25789 25794 and 26398.....
190J	22553	Corder Screw.....

DARNING FOOT

No.	Plate	Name
121091	-----	Darning Foot.....
*121125	-----	" " Guide.....
*121126	-----	" " Shank.....
121092	-----	" " " 121126 with 121125
121093	21454	" " Spring.....
121094	22526	Darning Foot (spring) complete, Nos. 121091 to 121093.....

EDGE STITCHER

No.	Plate	Name
36865	22527	Edge Stitcher.....

EMBROIDERY ATTACHMENT

FOR ONE THREAD

No.	Plate	Name
120876	4938	Driving Lever with 120877 and two 9859.....
22232	4938	Driving Lever Friction Washer.....
26784	4938	" " Hinge Stud.....

From the library of: Diamond Needles Corp.

No.	Plate	Name
26523	4938	Driving Lever Washer.....
26524	4938	Frame with 26525.....
26525	4938	" Block.....
26527	4938	Looper.....
468C	4938	" Set Screw.....
26528	4938	Scroll with 468C.....
26529	4938	" Carrier with 26531.....
22232	4938	" " Friction Washer....
26530	4938	" " Hinge Stud.....
26531	4938	" " Pin.....
26532	4938	" Cover.....
26533	4938	" Driving Lever with 26534...
26534	4938	" " " Stud.....
26535	4938	Spool Pin, for Arm of Machine....
120877	4938	Thread Bracket.....
9859	4938	" " Rivet.....Per 100
26537	4938	" Eyelet.....
26785	4938	" Retaining Spring.....
240J	4938	" " " Screw.....
26538	22526	Embroidery Attachment complete, Nos. 240J,26523,26524,26527 to 26530,26532,26533,26535,26537, 26784,26785,120876 and two 22232.....

EMBROIDERY ATTACHMENT

FOR TWO THREADS

No.	Plate	Name
35483	4937	Body.....
35484	4937	" Block.....
12152	4937	" " Rivet.....Per 100
35485	4937	Driving Lever.....
35486	4937	" " Arm (lower).....
35487	4937	" " " (upper).....
35488	4937	" " " Guide.....
35489	4937	" " " Hinge Stud.....
35490	4937	" " " Spring.....
35491	4937	" " Hinge Stud.....
35492	4937	Thread Carrier (left).....
35493	4937	" " " Hinge Stud...
35494	4937	" " (right).....
50139B	4937	" " " Hinge Screw.
35495	4937	" " Friction Plate.....
35496	4937	Embroidery Attachment, Nos. 190B, 12152,35483 to 35488,35490 to 35495,35498,50139B and two 35489.....

No.	Plate	Name
190B	22553	Embroidery Attachment Screw.....
35497	4936	Spool Bracket.....
35498	4936	" " Stud.....
1422B	4936	" " Tension Regulating Thumb Screw.....
35499	4936	Spool Bracket Tension Spring.....
35500	4936	" " " " Posi- tion Pin.....
35500	4936	Spool Bracket Thread Guide Pin....
35501	4936	" " Wire.....
35502	4936	" " " Hinge Stud.....
35503	4936	" " " " Washer
35504	4936	Spool Bracket complete, Nos.1422B, 35497, 35499,35502,35503 and two each 35500 and 35501.....
35505	-----	Embroidery Attachment complete Nos. 35496 and 35504.....

FEED COVER PLATE

No.	Plate	Name
15359	22510	Feed Cover Plate.....

FELLER (Foot)

No.	Plate	Name
120914	22527	Feller (foot).....

HEMMER (Foot)

No.	Plate	Name
120962	22527	Hemmer (foot) for 1/8 in. hem....
25893	22527	" " " 1/4 in. hem....

HEMSTITCHER

No.	Plate	Name
120687	22526	Hemstitcher with Yielding Presser Plate.....

From the library of: Diamond Needle Corp

KNEE LIFTER

No.	Plate	Name
5596	22556	Bell Crank.....
56848	-----	" " 5596 with 5599 and 5601
5599	22556	" " Bracket.....
159E	22553	" " " Screw.....
5601	22553	" " Hinge Pin.....
5735	22556	" " Spring.....
5598	22556	Bell Crank complete, Nos. 5735 and 56848.....
22806	22556	Lifting Lever with 196F.....
52028	22556	" " Connecting Rod.....
12416	22556	" " " " Joint
76ZB	22553	" " " " " "
		Hinge Screw.....
1521J	22553	Lifting Lever Connecting Rod Lock Nut.....
802ZB	22553	Lifting Lever Hinge Screw.....
22807	22556	" " Link.....
22808	22553	" " " Hinge Stud.....
196F	22553	" " " " " Set Screw.....
2763TM	22557	Rock Shaft.....
**7539	22557	" " Hanger with two wood screws 1 in. No. 10.....
6335TM	22557	Rock Shaft Knee Arm.....
**2766	22557	" " " " Hub with 356C.
**356C	22553	" " " " " Set Screw.
**6336	-----	Rock Shaft Knee Arm complete, Nos. 2766, 2767 and 6335.....
**2767	22557	Rock Shaft Knee Plate with 356C...
**356C	22553	" " " " " Set Screw...
**6337	22557	" " Lifting Bracket with two 356C.....
2778	22557	Rock Shaft Lifting Bracket Hook...
**356C	22553	" " " " " " Set Screw.....
**356C	22553	Rock Shaft Lifting Bracket Set Screw.....
**2770	22557	Rock Shaft Stop Dog with 356C.....
**356C	22553	" " " " " Set Screw.....
22809	22557	Rock Shaft complete, Nos. 2763, 2778, 6336, 6337 and two each 2770 and 7539.....
22810	-----	Knee Lifter complete, Nos. 76ZB, 802ZB, 1521J, 5598, 12416, 22806 to 22809, 52028 and two 159E...

Note: When ordering Rock Shaft Parts marked with a double asterisk (**) state Mar-proof Brown Enamel.

MACHINE COVER

No.	Plate	Name
121448	-----	Machine Cover (brown duck).....
121548	-----	" " " " professional model.....

NEEDLE THREADER (Universal)

No.	Plate	Name
121541	22526	Needle Threader (universal).....
121424	22526	" " Hook.....
140157J	21454	" " " Screw.....

PRESSER FEET

No.	Plate	Name
15429	22528	Presser Foot (needle hole on right hand side) for stitching on edge and inserting braid.....
125035	22528	Presser Foot (needle hole on left hand side) for stitching on edge and inserting braid.....
121441	22528	Presser Foot for gathering.....
25978	22528	" " (single toe) for gathering.....
36055	22528	Presser Foot with 665P and 36056, for blind stitch braiding, for soutache braid.....
36056	21454	Presser Foot Braid Guide.....
Note: When ordering Nos. 36055 or 36056, send sample of braid for which it is to be used.		
665B	22508	Presser Foot Braid Guide Screw....
36058	22528	" " with 665B and 36059, for blind stitch cording to turn small curves.....
36059	21454	Presser Foot Cord Guide.....
Note: When ordering Nos. 36058 or 36059, send sample of cord for which it is to be used.		
665B	22508	Presser Foot Cord Guide Screw....
36067	22528	" " for braiding, for art work, for braid, 1/16 in. to 3/16 in. wide.....

Note: When ordering No. 36067, state the size or send sample of the braid for which it is to be used.

From the book: Mar-proof Needle Corp.

QUILTER

No.	Plate	Name
35932	22528	Quilter.....

TUBULAR TRIMMING ATTACHMENT

No.	Plate	Name
35018	22556	Strip Delivery Blade.....
120824	4958	" Wire.....
35984	4958	Presser Foot (strip folding) with tube.....
35985	-----	Tubular Trimming Attachment complete, for making 3/32 in., 1/8 in. and 5/32 in. trimmings. Nos. 35018, 35984 and 120824..

Note: When ordering No. 35985, state size required.

UNDER BRAIDER

No.	Plate	Name
121547	22529	Under Braider.....
25637	22529	" " Foot.....

OBSOLETE PARTS

No.	Plate	Name
45314	22511	Arm Shaft (horizontal) Bevel Gear (right hand spiral) with two 12590, obsolete, superseded by 45346, not interchangeable....
45295	22511	Arm Shaft (upright) Bevel Gear (lower) right hand spiral, with two 12590, obsolete, superseded by 45347, not interchangeable.....
45315	22511	Arm Shaft (upright) Bevel Gear (upper) left hand spiral, with two 12590, obsolete, superseded by 45348, not interchangeable.....

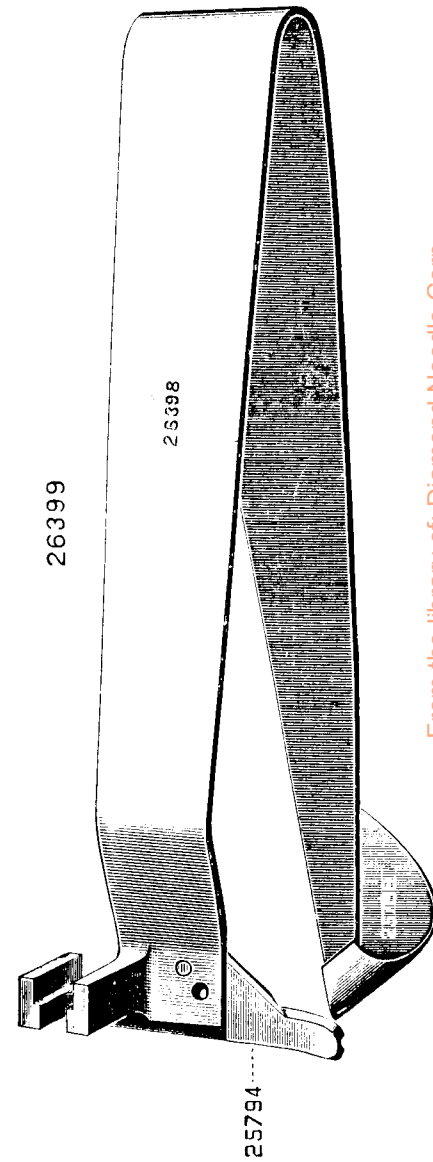
No.	Plate	Name
45243	22511	Rotating Hook Driving Shaft Bevel Gear (back) left hand spiral, with two 12590, obsolete, superseded by 45853, not interchangeable.....
45316	22511	Rotating Hook Driving Shaft Bevel Gear (front) right hand spiral with two 12590, obsolete, superseded by 45852, not interchangeable.....
45317	22511	Rotating Hook Shaft Bevel Gear (left hand spiral) with two 11200, obsolete, superseded by 45349, not interchangeable....

SINGER Needles should be used
in SINGER Machines.
These Needles and their Containers
are marked with the
Company's Trade Mark "SIMANCO. 1*" 1

Needles in Containers marked
"FOR SINGER MACHINES"
are NOT **SINGER** made needles. 2

SINGER Needles should be used
in SINGER Machines.
These Needles and their Containers
are marked with the
Company's Trade Mark "SIMANCO. 33" 1

Needles in Containers marked
"FOR SINGER MACHINES"
are NOT **SINGER** made needles. 2



From the library of: Diamond Needle Corp

PLATE 4936 - FULL SIZE

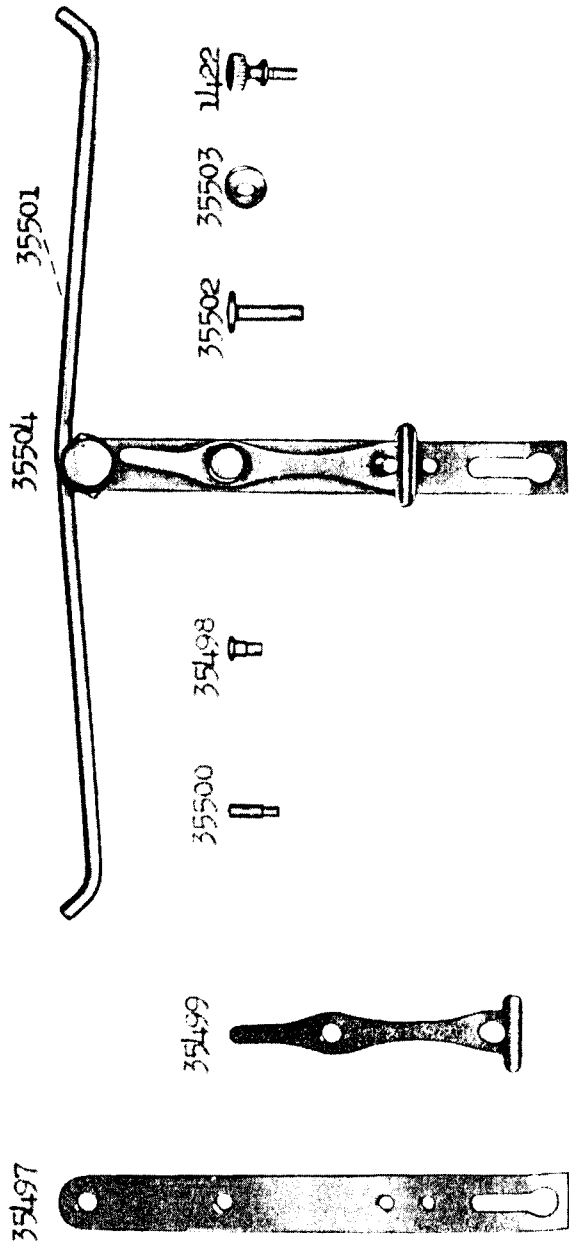


PLATE 4937 - FULL SIZE

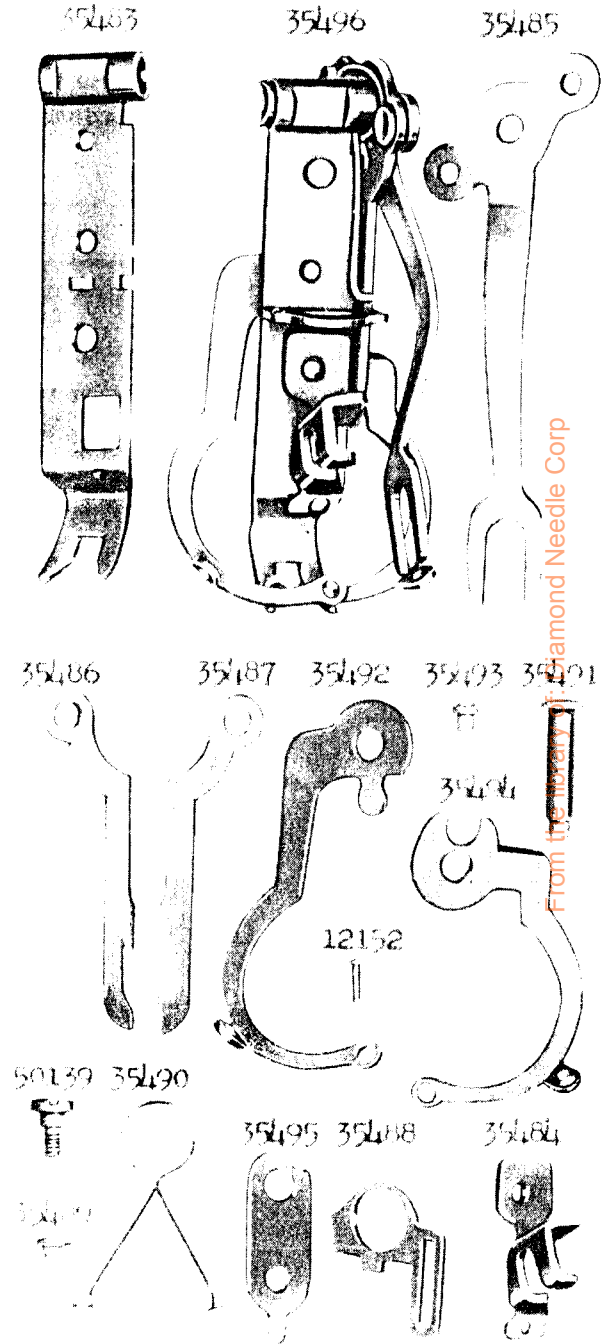


PLATE 4938 - FULL SIZE

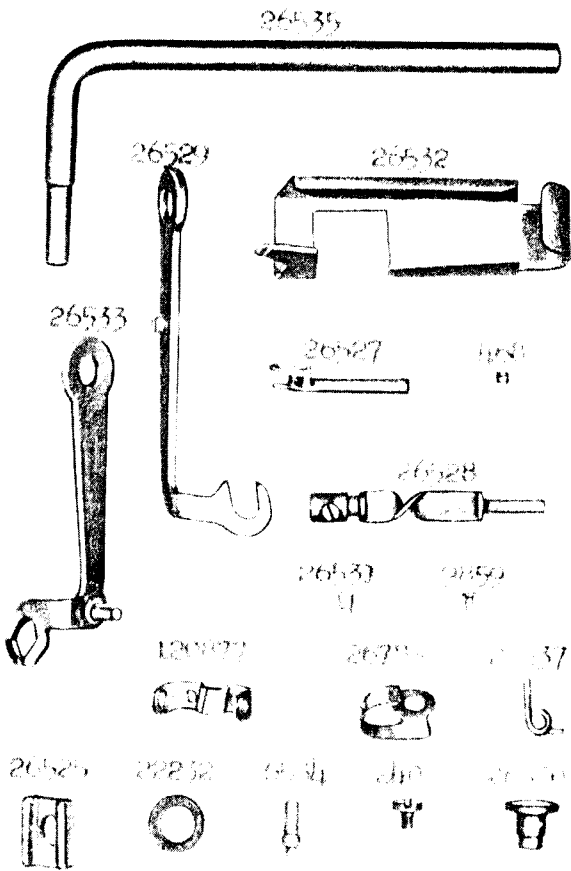
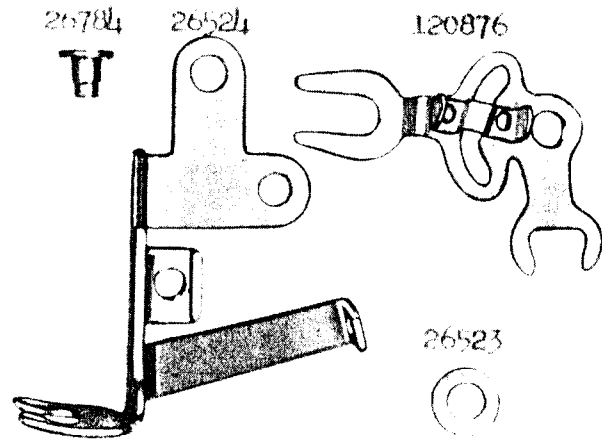
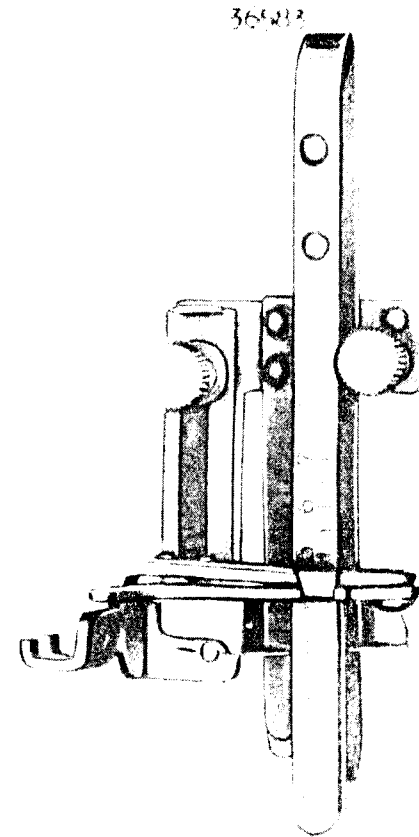
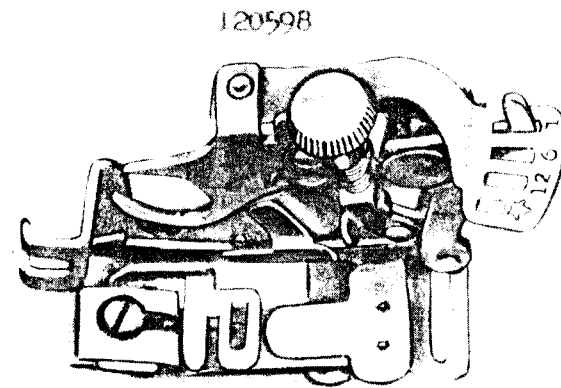


PLATE 4942 - FULL SIZE



From the library of: Diamond Needle Corp

PLATE 4956 - FULL SIZE

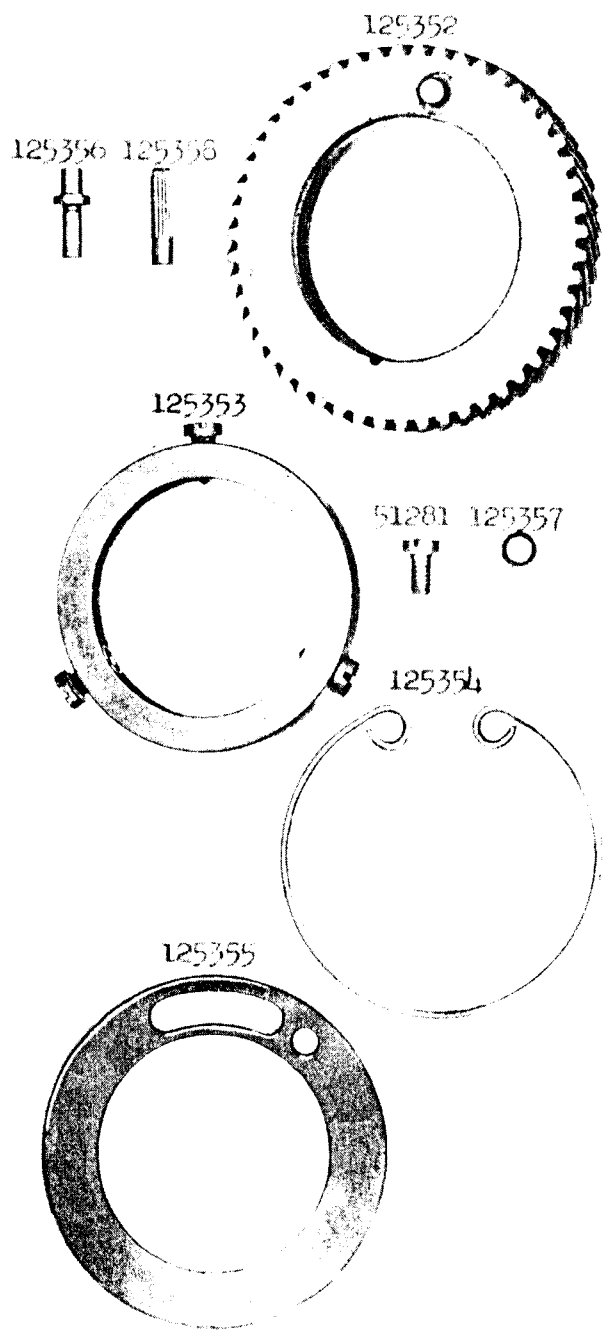
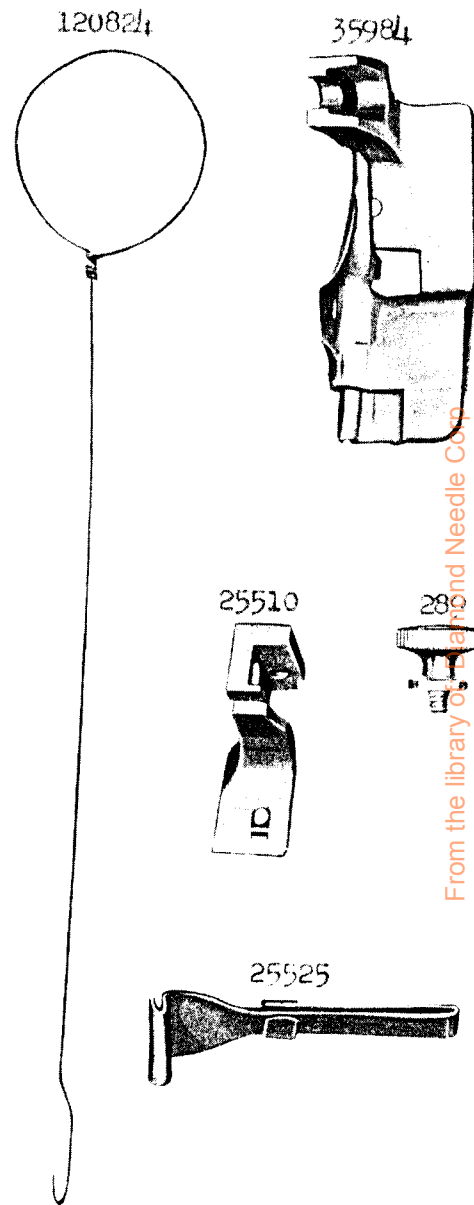


PLATE 4958 - FULL SIZE



From the library of the Grand Needle Corp

PLATE 4960 - ONE-HALF SIZE

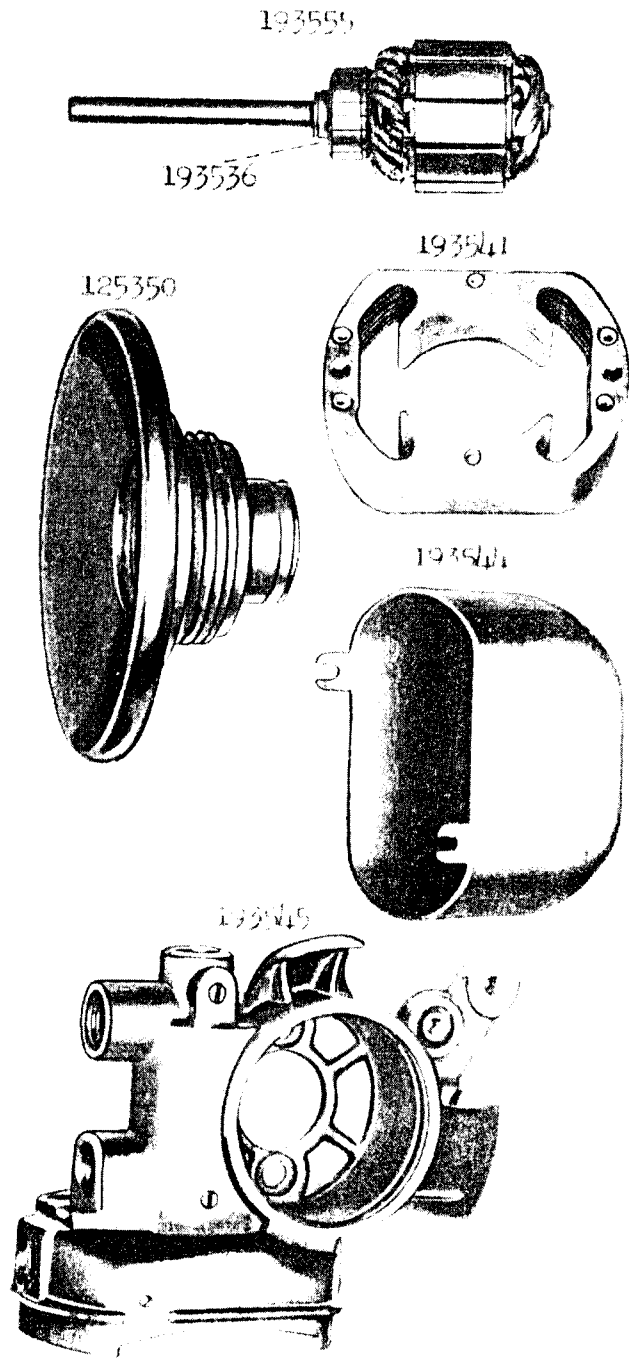


PLATE 21454 - FULL SIZE



From the library of: Diamond Aircraft Corp

PLATE 22501 - FULL SIZE

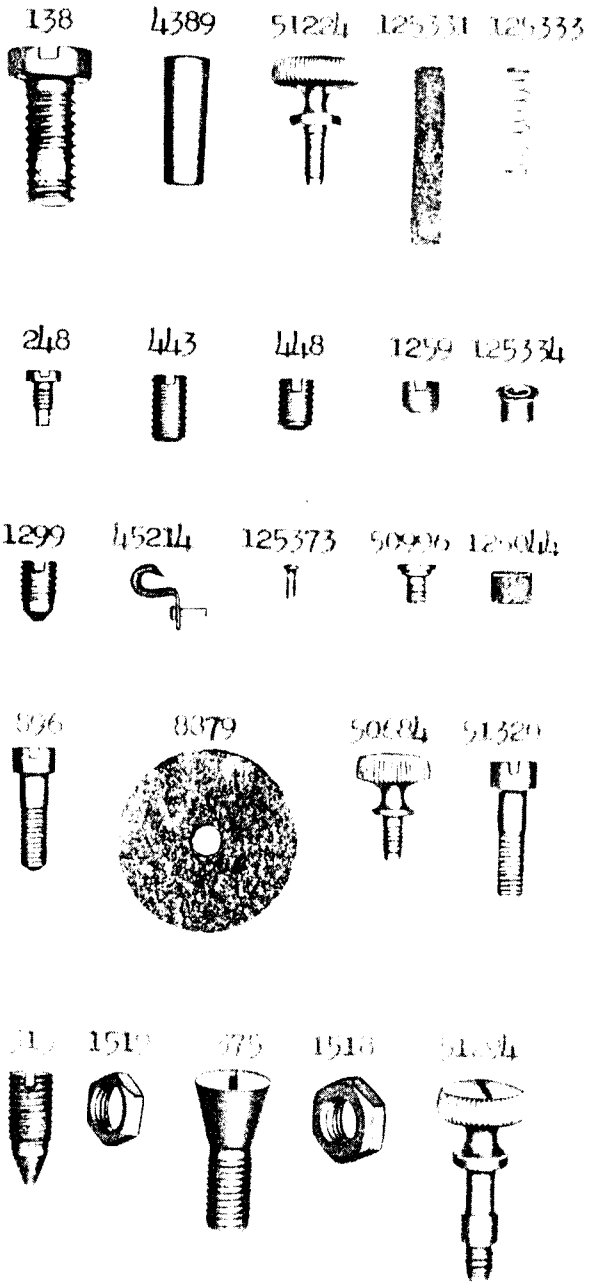
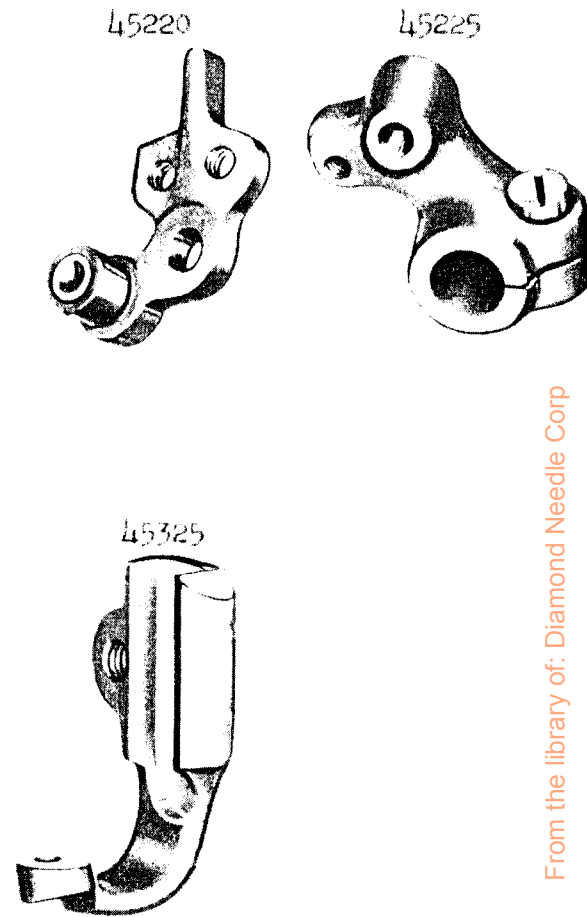


PLATE 22503 - FULL SIZE



From the library of: Diamond Needle Corp

PLATE 22504 - FULL SIZE

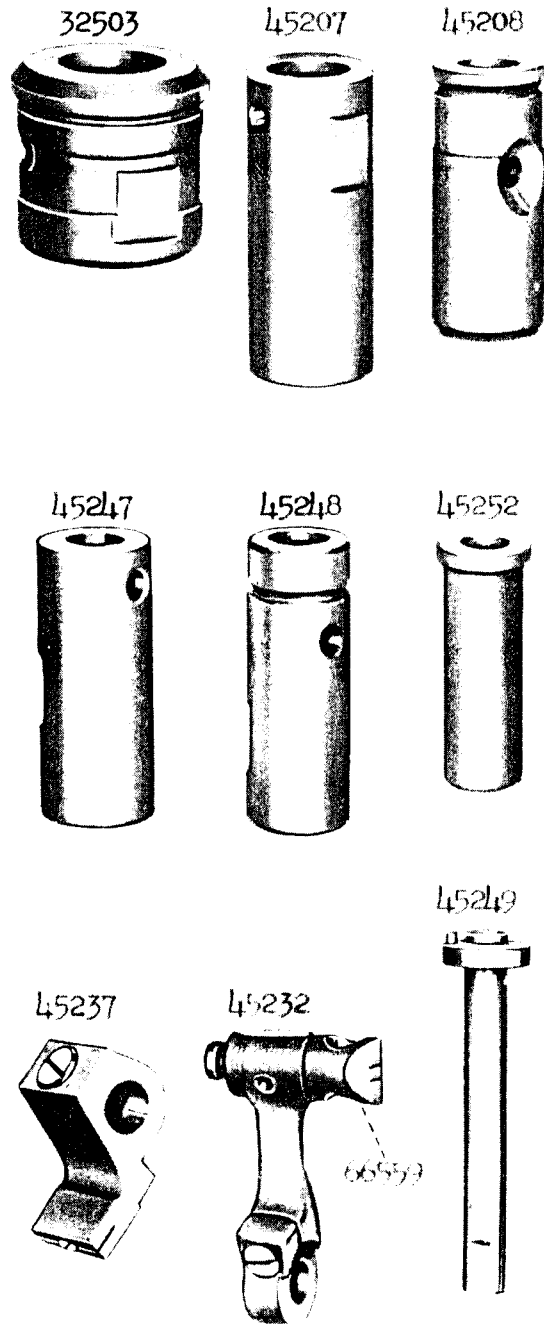
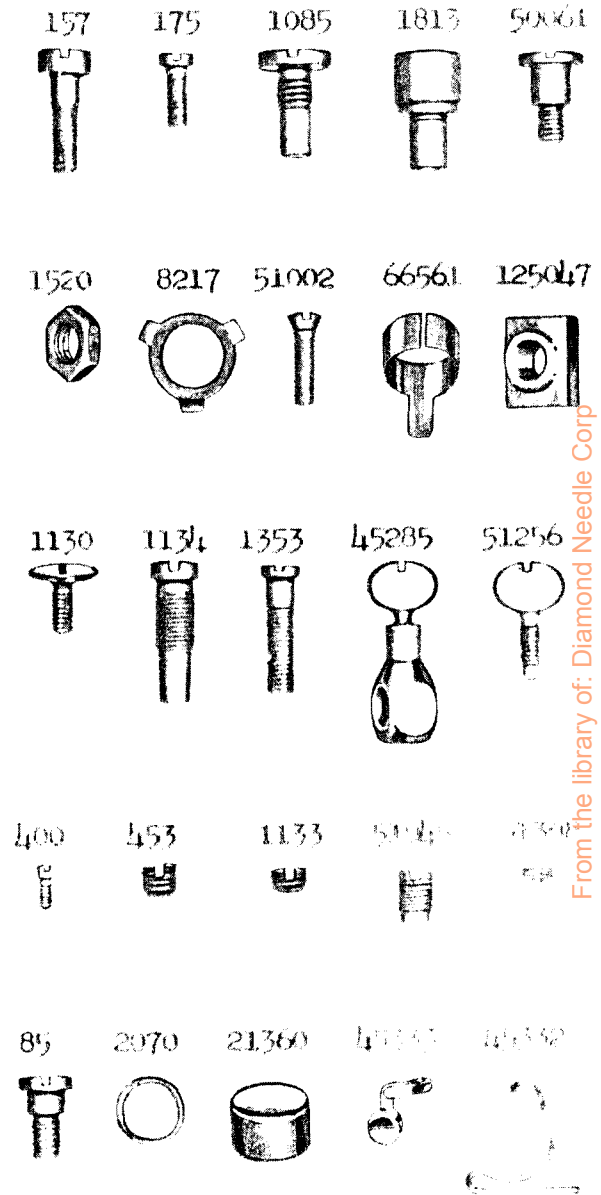


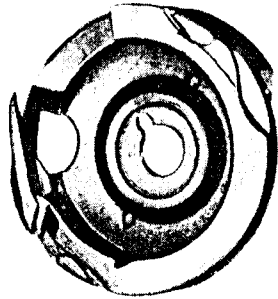
PLATE 22505 - FULL SIZE



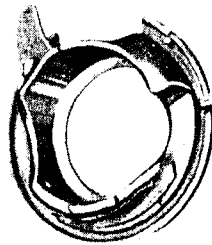
From the library of: Diamond Needle Corp

PLATE 22507 - FULL SIZE

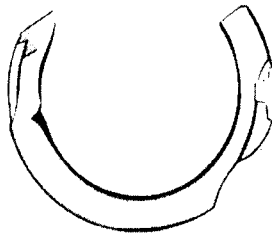
45273



45276



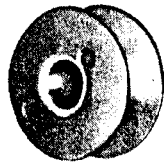
45278



45292



32522



45281

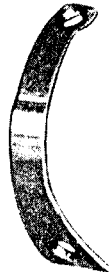


PLATE 22508 - FULL SIZE

45277 45279 45280 45293 45289



239



707



1172



1173



51306



203



207



335



50150



51302



665



1550



32519



45221



45282



246



440



1120



50463



51282



66581



66752



125385



From the library of: Diamond Needle Corp

PLATE 22509 - ONE-HALF SIZE

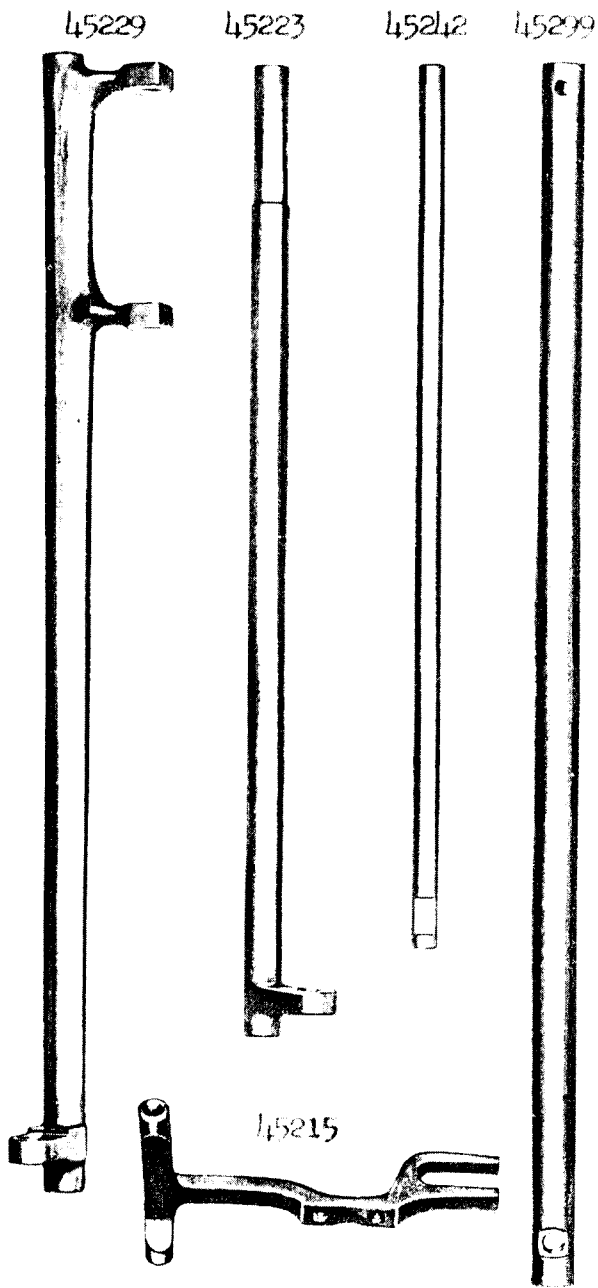
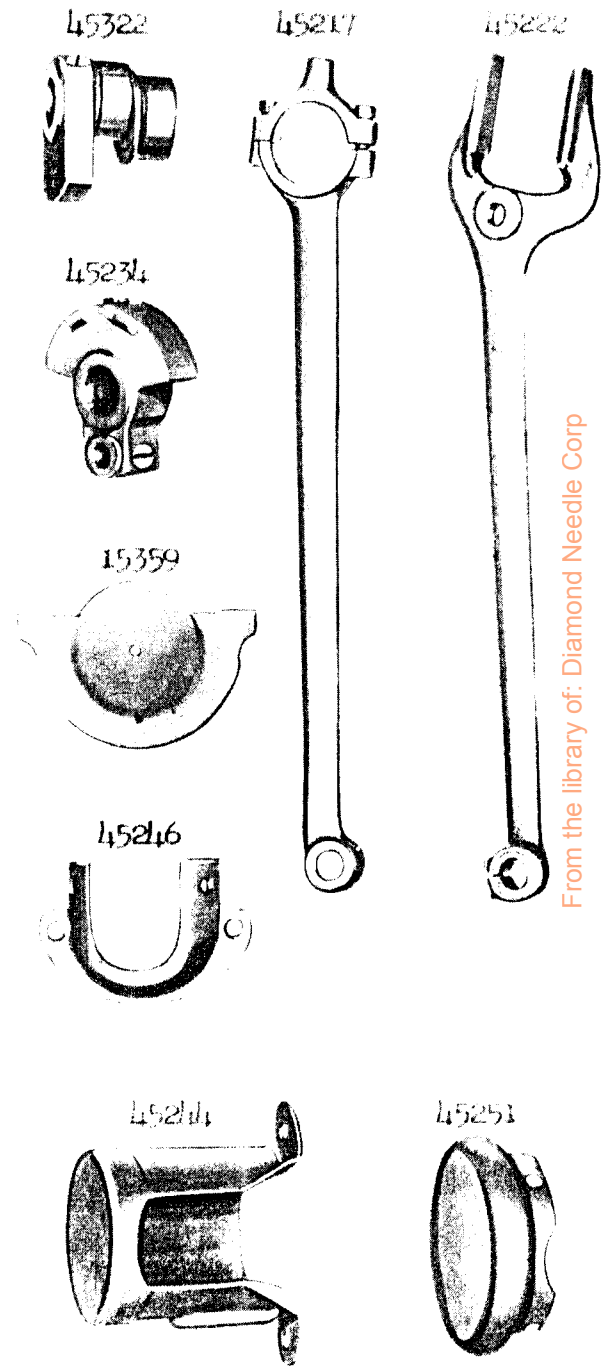


PLATE 22510 - ONE-HALF SIZE



From the library of: Diamond Needle Corp

PLATE 22511 - FULL SIZE

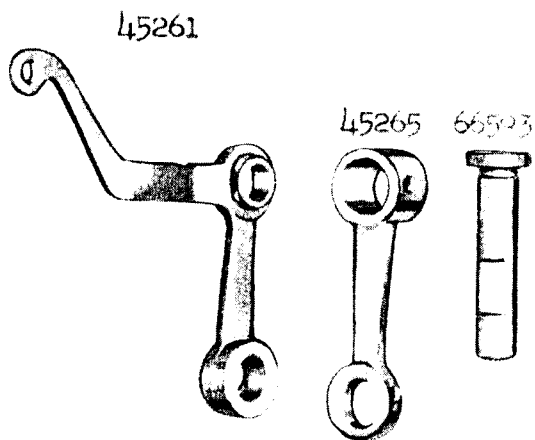
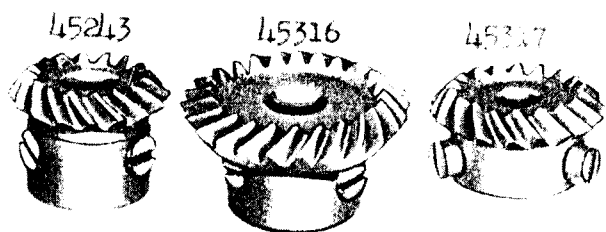
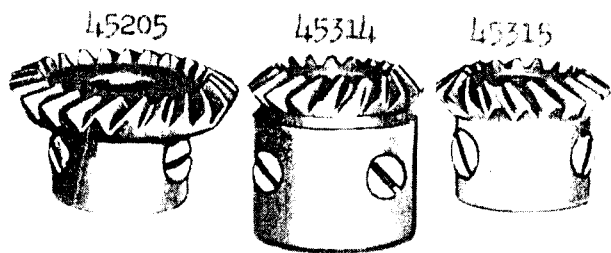
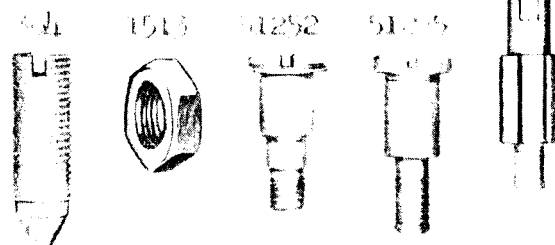
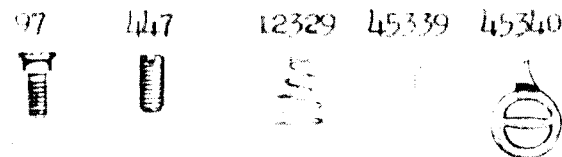
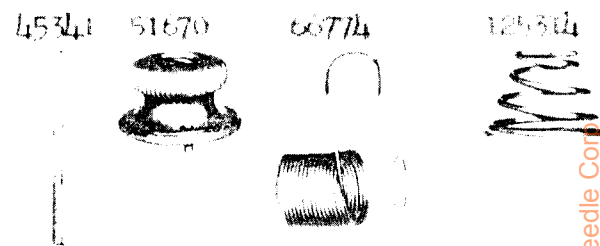
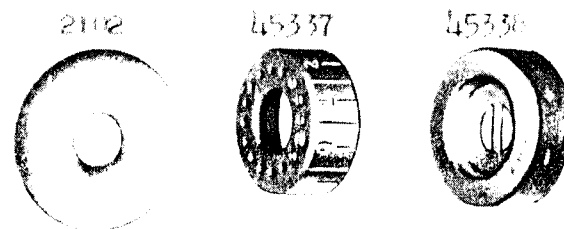
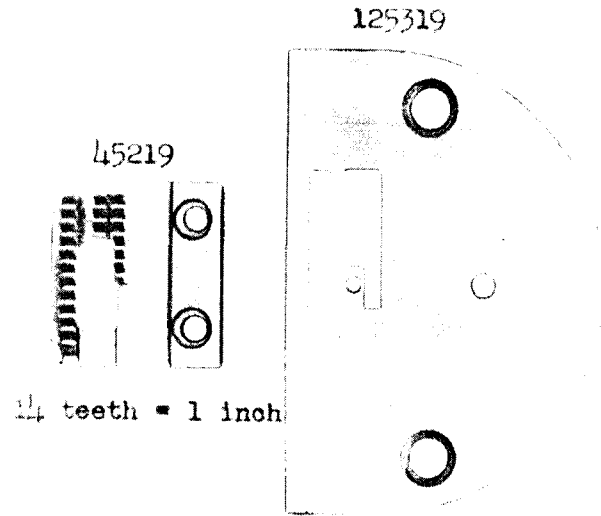


PLATE 22512 - FULL SIZE



From the library of: Diamond Needle Corp.

PLATE 22513 - FULL SIZE



45321



208

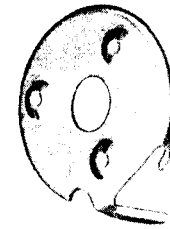


531

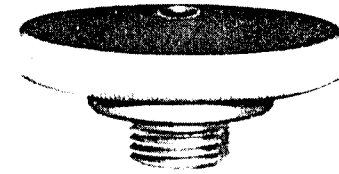


PLATE 22514 - FULL SIZE

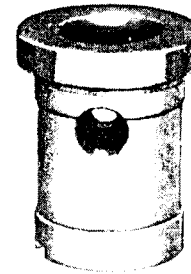
45343



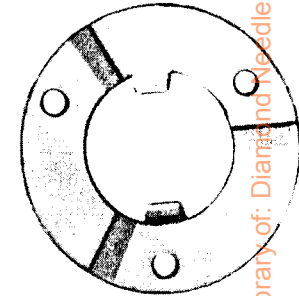
51280



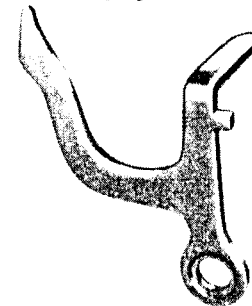
45294



125359



32573

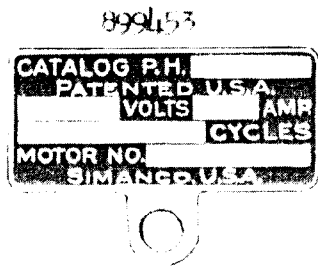
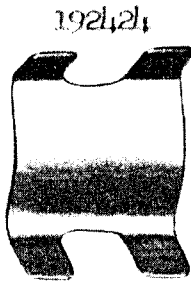


32578

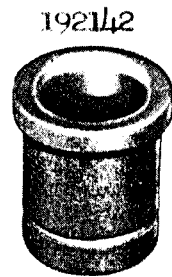
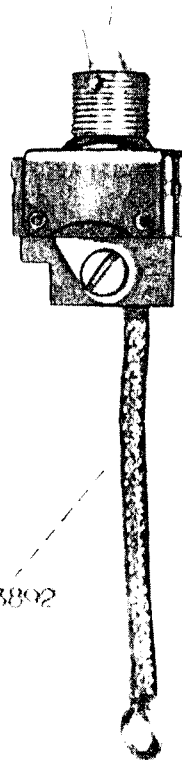


From the library of: Diamond Needle Corp

PLATE 22515 - FULL SIZE



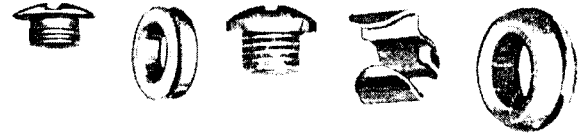
194274



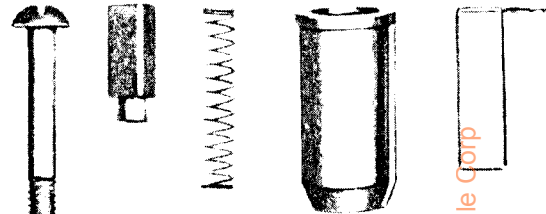
193892

PLATE 22516 - FULL SIZE

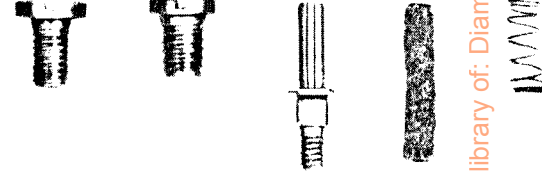
50617 193542 193543 193640 727501



51006 192177 192180 193516 194113



51285 51293 192793 193526 193527



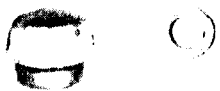
224 462 882 192790 51281



192691 192692 1768 51093 50657



51582 701719



From the library of: Diamond Needle Corp

PLATE 22517 - FULL SIZE

In Writing Orders for Complete
Field Coils refer to Pages 15 and 16
to obtain number and required voltage.

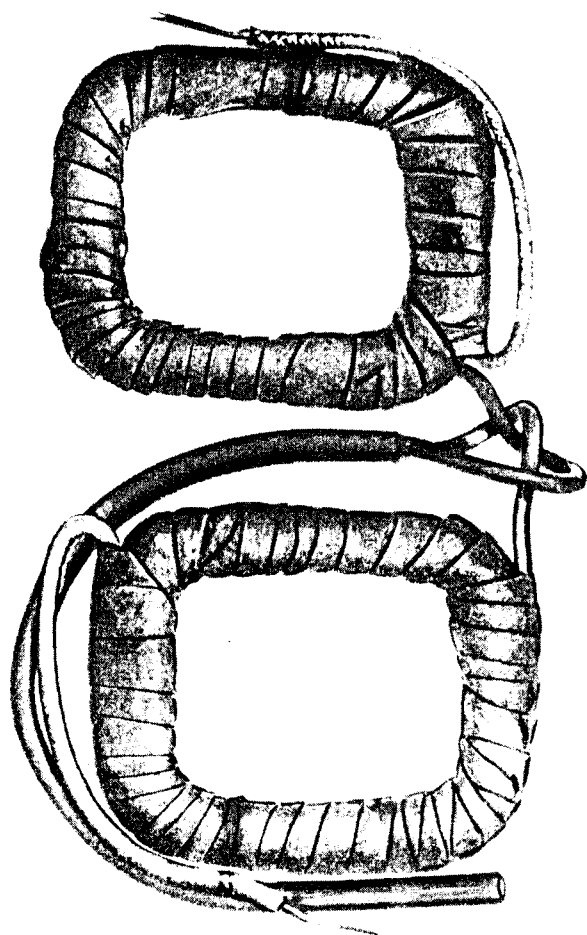
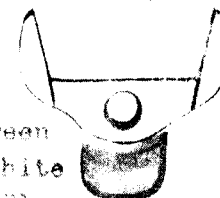
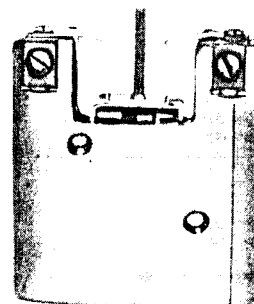


PLATE 22519 - ONE-HALF SIZE

192117



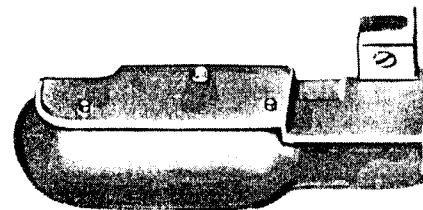
192111-32 to 55 Volts, Green
192140-95 to 115 Volts, White
192141-150 to 250 Volts, Blue



194120



193931



From the library of: Diamond Needle Corp

PLATE 22524 - FULL SIZE

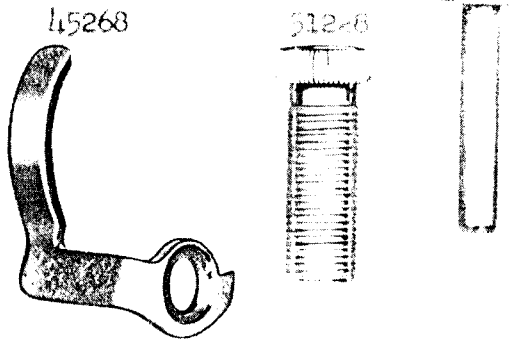
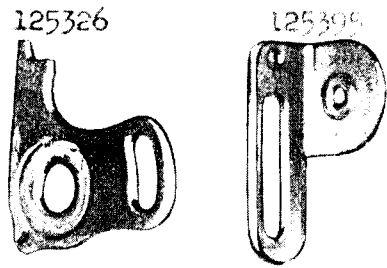
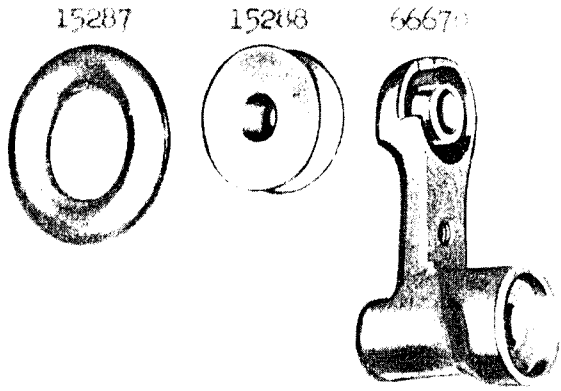
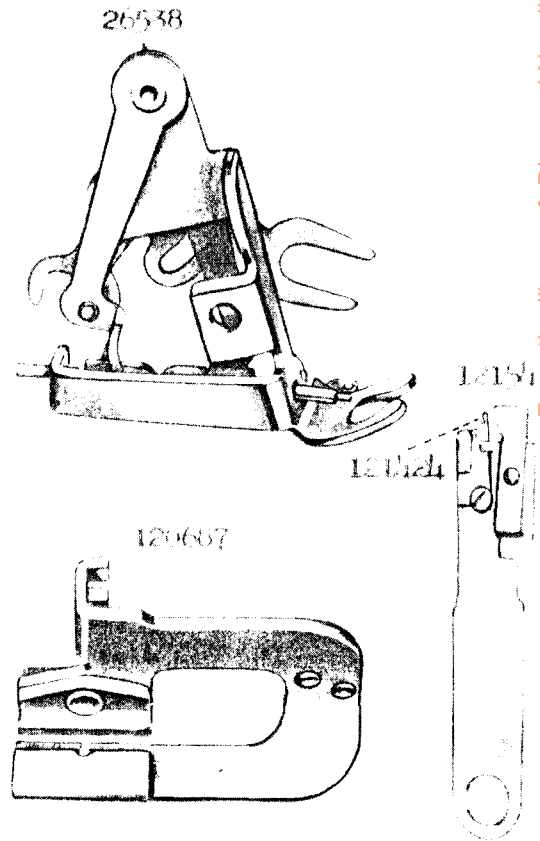
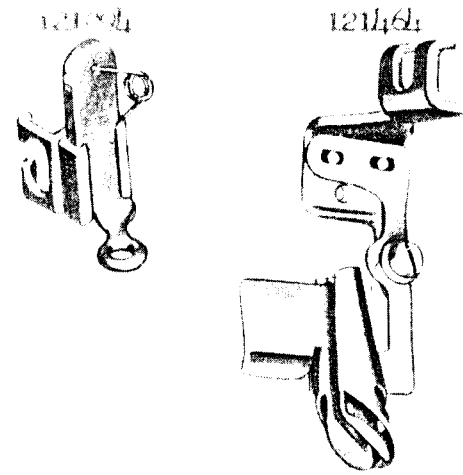


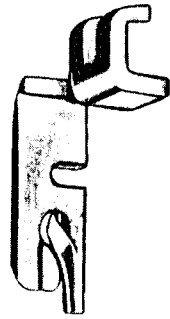
PLATE 22526 - FULL SIZE



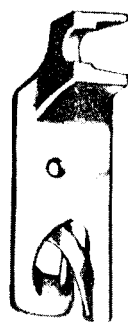
From the library of: Diamond Needle Corp

PLATE 22527 - FULL SIZE

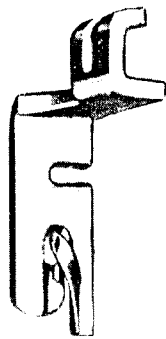
120855



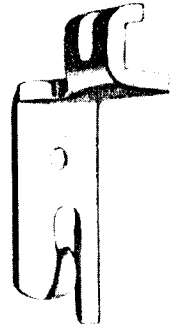
25893



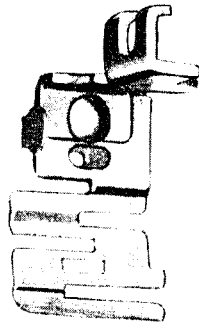
120962



120914



36865



35931

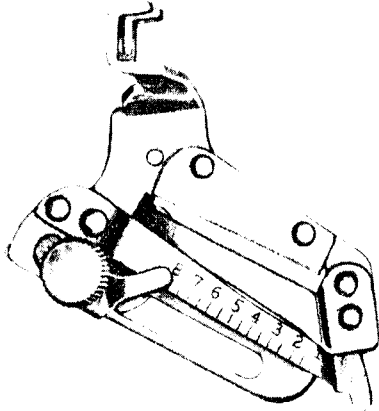


PLATE 22528 - FULL SIZE

15429



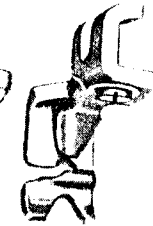
25978



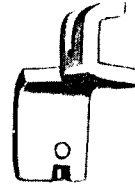
36055



36058



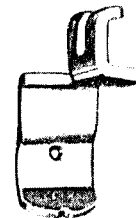
36067



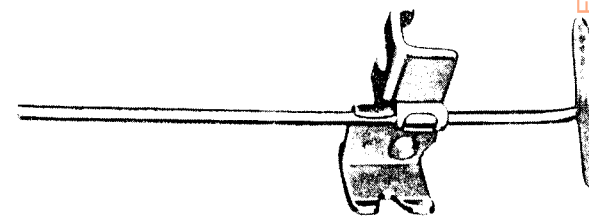
125035



121111



35932



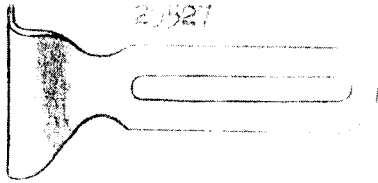
From the library of: Diamond Needle Corp

PLATE 22529 - FULL SIZE

25637



23527



121517

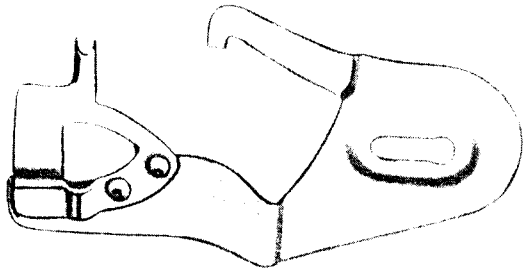


PLATE 22551 - ONE-HALF SIZE

02045



0366



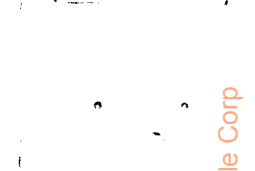
17323



45335



45255



66558



22805



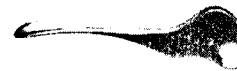
125339



32675



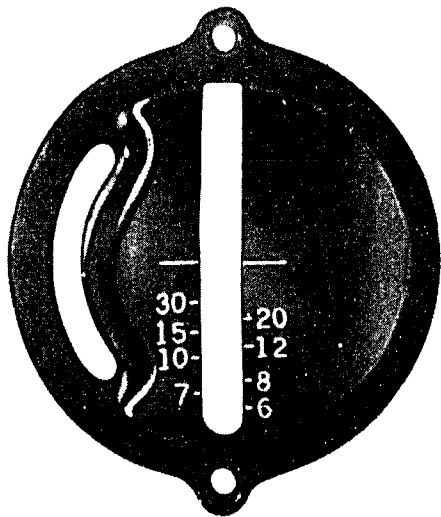
66564



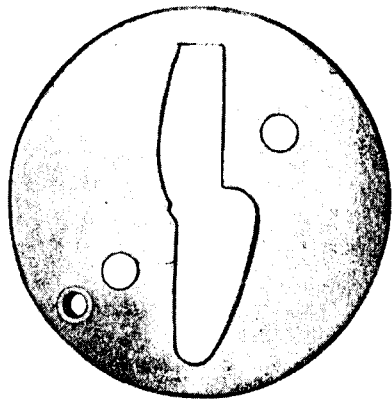
PROPERTY OF Diamond Needle Corp

PLATE 22552 - FULL SIZE

45306



45308



45305



51312



45310



125400

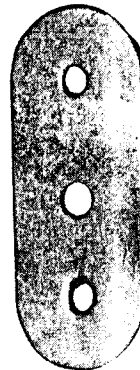


PLATE 22553 - FULL SIZE

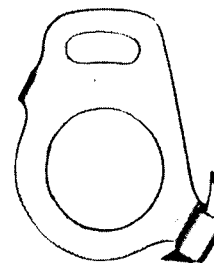
2007



45209



45345



125365



196



207



624



51401



51484



76



159



190



51367



51399



701994



51623



193919



802



356



641



5601



22808



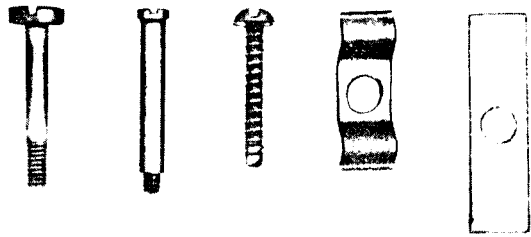
1521



From the library of Diamond Needle Corp

PLATE 22554 - FULL SIZE

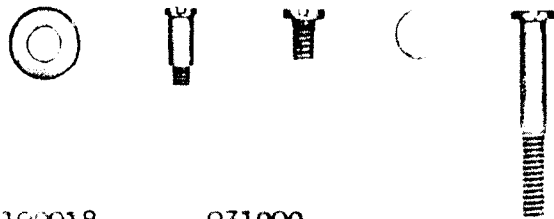
126 140101 140102 193908 194479



792 1549 1607 193989 964317



23258 51340 140100 194514 140103



192918



931090

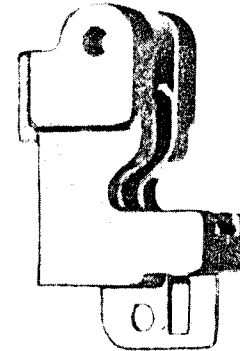


PLATE 22555 - FULL SIZE

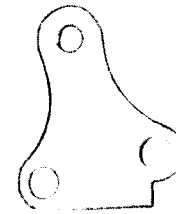
193028



194324



194403



194405



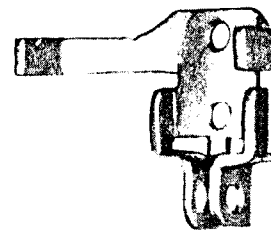
192985



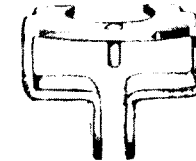
194421



194402



194417



From the library of: Diamond Needle Corp

PLATE 22556 - ONE-HALF SIZE

25537



120862

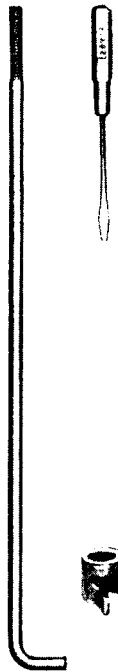


35018



22806

52028 120378



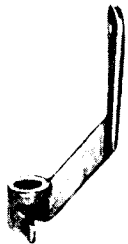
5735



12416



22807



5598

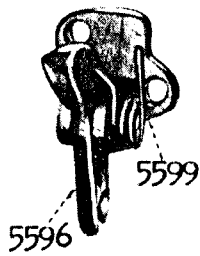
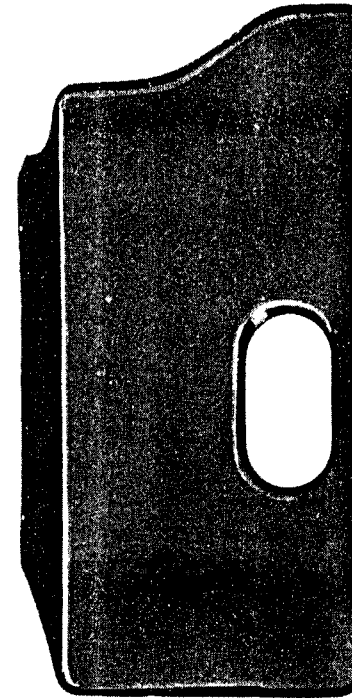


PLATE 22557 - ONE-FOURTH SIZE

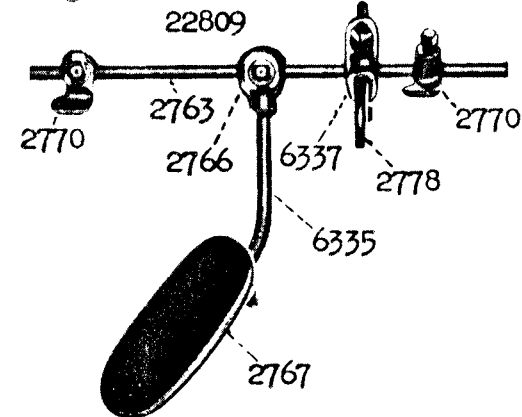
24079



7539



7539



from the library of: Diamond Needle Corp

PLATE 22558 - ONE-FOURTH SIZE

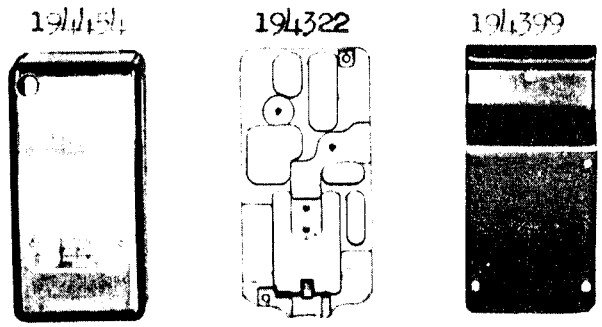
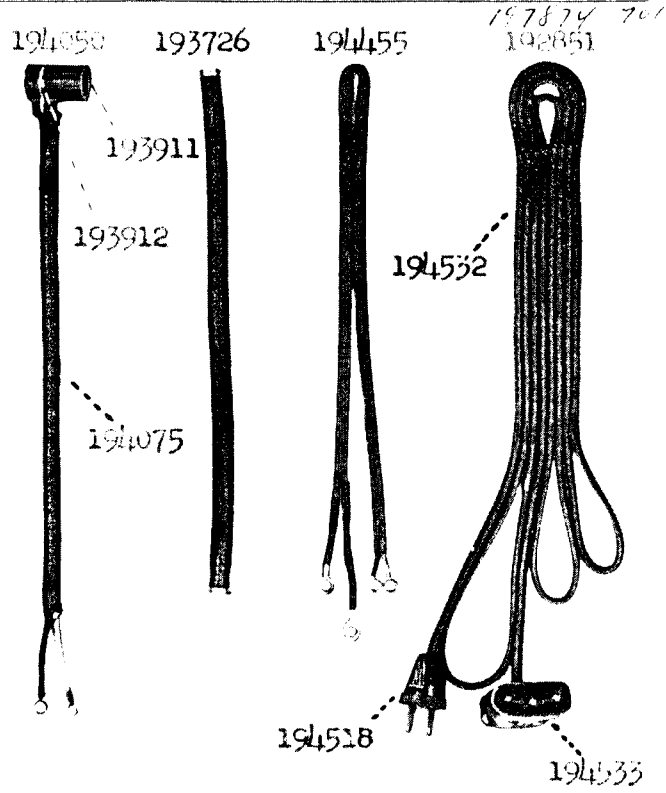
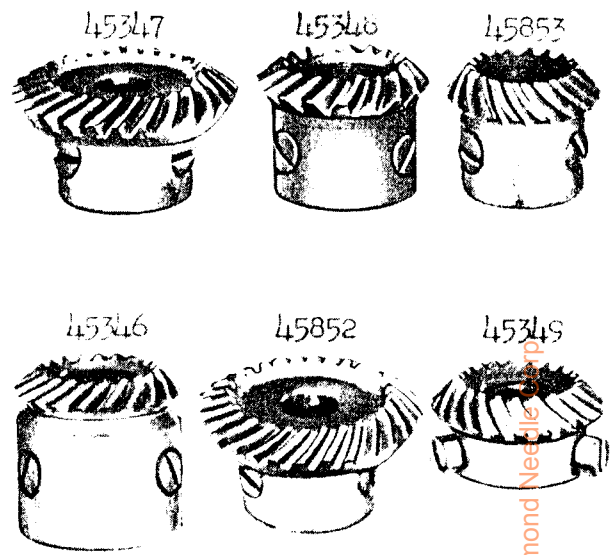


PLATE 22559 - FULL SIZE



From the library of: Diamond Needle Corp